



# Installation Manual

PHI 3.8-M™  
Battery Module

# SimpliPhi Your Energy Security and Independence

and gain control of your own power.

SimpliPhi Power helps you manage your power as a personal resource. Anytime. Anywhere. SimpliPhi energy storage optimizes integration of any power generation source – solar, wind, generator – on or off grid, and protects your home and mission-critical business functions from power outages and intermittency. SimpliPhi storage technology reduces operating temperature constraints, toxic coolants and the risk of thermal runaway. Safe lithium ferrous phosphate (LFP). No cobalt. No toxic hazards.

SimpliPhi's battery technology utilizes the industry's most environmentally benign chemistry (LFP) combined with proprietary architecture and power electronics (BMS) to create a portfolio of high performance, scalable and enduring energy storage solutions that provide power security, resilience and daily cycling for savings on your utility bill – all with a 98% efficiency rate.

---

*SimpliPhi Power offers proprietary, commercially available energy storage and management systems that are safe, non-toxic, reliable, durable, efficient, highly scalable, and economical over the lifetime of the PHI Battery.*

# Table of Contents

1.0 – Introduction .....	6
1.1 – Online Resources .....	6
1.2 – Technical Support .....	6
1.3 – Product Overview.....	6
1.3.1 – Battery Management System (BMS) .....	6
1.3.2 – Built-In Breaker .....	7
1.4 – Specifications.....	8
2.0 – Safety .....	9
2.1 – General Safety Instructions .....	9
2.2 – Response to Emergency Situations .....	9
3.0 – Pre-Installation .....	10
3.1 – PHI Battery Performance .....	10
3.2 – PHI Battery System Sizing .....	10
3.2.1 – Sizing for Maximum Instantaneous Discharge (Load Rate) .....	10
3.2.2 – Sizing for Maximum Instantaneous Charge Rate (DC Coupled) .....	11
3.2.3 – Sizing for Maximum Instantaneous Charge Rate (AC Coupled).....	12
3.2.4 – Overall Battery System Sizing .....	12
4.0 – Installation.....	13
4.1 – Installation Options .....	13
4.2 – Environmental Considerations.....	13
4.2.1 – Charging at Temperatures Below Freezing .....	13
4.2.2 – Explosive Gas Precautions .....	13
4.2.3 – Anti-Corrosion Protection .....	13
4.3 – Mounting Hardware.....	14
4.4 – Dimensions and Weight .....	14
4.5 – PHI Battery Connection Terminals.....	15
4.5.1 – Batteries with Threaded Studs .....	15
4.5.2 – Torque Value for Batteries with Threaded Studs .....	15
4.6 – Wiring.....	16
4.6.1 – Increasing Storage Capacity via Parallel Wiring.....	16
4.6.2 – Parallel Wiring Batteries with Threaded Studs using Battery Cables.....	16
Helpful Tips:.....	18
4.6.3 – Parallel Wiring Batteries with Threaded Studs using Interconnecting Busbars.....	20
4.7 – Battery System Commissioning .....	21
4.8 – Battery Bank Expansion .....	24
5.0 – Programming .....	25
5.1 – Operating Parameters Related to Cycle Life .....	25
6.0 – Troubleshooting .....	26
Appendix A – PHI Battery Safety & Green Attributes, Certifications .....	28
Appendix B – PHI Battery Bank Sizing Guide.....	30
Appendix C – PHI Approved External Chargers .....	32



**CAUTION: THESE 5 THINGS WILL VOID THE PHI WARRANTY & DAMAGE THE BATTERIES.  
READ IN FULL PRIOR TO BATTERY INSTALLATION**

The following abbreviated guidelines do NOT encompass all PHI battery Warranty details. Failure to adhere to the Warranty and Installation Manual requirements will Void the Warranty. Read the battery's complete Warranty prior to installation and register the battery according to the form found at the bottom of the same web page address: <https://simpliphipower.com/wp-content/uploads/documentation/ampliphi-series-phi-series/simpliphi-power-ampliphi-battery-phi-battery-warranty.pdf>

CAUTION: The following will result in damage to your PHI batteries and will Void the Warranty:

1. Incorrect battery wiring and/or installation
  - A. Verify polarity at all connections with a standard voltmeter (1) before energizing the system and (2) on batteries with threaded stud connections, before switching the built-in circuit breaker to the "ON" position. Reverse polarity at the PHI Battery terminals will Void the Warranty and destroy the PHI Batteries.
  - B. PHI Batteries must be **fully charged before commissioning** (i.e. before connecting loads). Failure to do so will damage the PHI batteries and Void the Warranty.
  - C. Lugs, washers and lug nuts must be installed according to the Installation Manual. Failure to do so will damage the PHI Batteries and Void the Warranty.
2. Charging the battery in sub-freezing temperatures.
3. Pairing the battery with incompatible equipment. Use of accessories not recommended or sold by the manufacturer may result in a risk of fire, electric shock, or injury to persons and will Void the Warranty.
  - A. Contact SimpliPhi Technical Support at (805) 640-6700 x 1 regarding the compatibility of any equipment not explicitly listed in the 'Integration Guides' section of the Product Documentation web page (<https://simpliphipower.com/product-documentation/>).
  - B. Refer to the SimpliPhi-Approved Chargers list (Appendix C of this document) for all compatible external / plug-in battery chargers. Use only a SimpliPhi-approved LFP battery charger if ancillary charging is required before installation, testing or troubleshooting. Failure to use a SimpliPhi-approved LFP battery charger will damage the PHI Battery and Void the Warranty.
4. Incorrect inverter and/or charge controller settings. Operating the PHI Battery in conjunction with equipment not programmed to the PHI Battery's settings will Void the Warranty.
  - A. Refer to the 'Integration Guides' section of the Product Documentation web page (<https://simpliphipower.com/product-documentation/>) for all inverter and charge controller settings.
  - B. Although each PHI Battery contains an internal Battery Management System (BMS) with circuitry that protects the PHI Battery cells from over-charge, over-discharge and extreme load amperage, the PHI Battery must always be installed with appropriate inverter and/or charge controller settings and power electronics to protect the PHI Battery from open solar photovoltaic (PV) voltage and other high voltage charging sources.
  - C. Failure to protect the PHI batteries from voltages higher than the battery voltage rating will destroy the PHI batteries, cause electrical fires and Void the Warranty.
5. Incorrect battery bank sizing.
  - A. Exceeding the PHI batteries' maximum continuous discharge rate or charge rate destroys the PHI batteries and will Void the Warranty.
  - B. Refer to Section 3.2 and Appendix B of this Manual for more information on how to accurately and correctly calculate the PHI battery bank capacity. Failure to do so will destroy the PHI batteries and Void the Warranty.



**MISE EN GARDE: LES CINQ POINTS CI-DESSOUS ANNULERONT VOTRE GARANTIE PHI ET ENDOMMAGERONT LES BATTERIES. LIRE L'INTÉGRALITÉ DE CE DOCUMENT AVANT L'INSTALLATION.**

Les instructions abrégées suivantes ne couvrent PAS tous les détails de la Garantie des batteries PHI.

Ne pas tenir compte des exigences du Manuel de Garantie et du Manuel d'Installation Annulera la Garantie.

Lire l'intégralité de ce document ainsi que le Manuel de Garantie de la batterie avant l'installation.

Enregistrez votre batterie PHI en utilisant le formulaire en bas de page du document en cliquant sur le lien ci-dessous. <https://simpliphipower.com/wp-content/uploads/documentation/amplphi-series-phi-series/simpliPhi-power-amplphi-battery-phi-battery-warranty.pdf>

**MISE EN GARDE:** Ce qui suit entraînera des dommages irréversibles à votre batterie et Annulera sa Garantie.

1. Un mauvais câblage et/ou une mauvaise installation de la batterie
  - A. Vérifier la polarité de tous les branchements à l'aide d'un voltmètre standard (1) avant de mettre le système sous tension et (2) sur les batteries munies de goujons filetés, avant de mettre le disjoncteur intégré en position « ON ». Une polarité inversée aux bornes de la Batterie PHI Annulera la Garantie et détruira les Batteries PHI.
  - B. Les Batteries PHI doivent être complètement chargées individuellement avant la mise en service (c.-à-d. avant de connecter les charges). Ne pas suivre ces instructions entraînera l'endommagement des batterie et l'Annulation de la Garantie.
  - C. Les cosses, les rondelles et les écrous doivent être installés conformément au Manuel d'Installation. Ne pas suivre ces instructions entraînera l'endommagement des batterie et l'Annulation de la Garantie.
2. Un chargement de la batterie en dessous 0°C (32° F).
3. Une utilisation de la batterie avec un équipement incompatible. L'utilisation d'accessoires non approuvés ou non vendus par le fabricant peut entraîner un risque d'incendie, de choc électrique ou de blessures pour les personnes et Annulera la Garantie.
  - A. Contactez le Support Technique de SimpliPhi au (805) 640-6700 x 1 pour vérifier la compatibilité de tout équipement ou accessoires qui ne sont pas listés dans la section « Guides d'Intégration » de la page internet de la Documentation Produit. (<https://simpliphipower.com/product-documentation/>).
  - B. Se reporter à la liste des Chargeurs Approuvés par SimpliPhi (Annexe C du présent document) pour tous les chargeurs de batterie externes / à connecteurs compatibles. Utiliser uniquement un chargeur de batterie LFP approuvé par SimpliPhi si une charge auxiliaire est nécessaire avant l'installation, la mise à l'essai ou le dépannage. Ne pas utiliser un chargeur de batterie LFP approuvé par SimpliPhi endommagera la Batterie PHI et Annulera la Garantie.
4. Un réglage incorrect de l'onduleur et/ou du contrôleur de charge. L'utilisation de la Batterie PHI en conjonction avec un équipement non programmé selon les paramètres de la Batterie PHI Annulera la Garantie.
  - A. Reportez-vous à la section « Guides d'intégration » de la page internet de la Documentation Produit. (<https://simpliphipower.com/product-documentation/>)
  - B. Chaque Batterie PHI contient un système de gestion interne (BMS) qui protègent les cellules de la Batterie PHI contre une surcharge, une décharge excessive et un ampérage trop fort . Cependant la Batterie PHI doit toujours être installée avec les réglages appropriés de l'onduleur et/ou du régulateur de charge et de l'alimentation électronique pour protéger la Batterie PHI d'une charge photovoltaïque (PV) à haute tension ou toute autre source à haute tension.
  - C. Le fait de ne pas protéger les batteries PHI contre des tensions supérieures à la tension nominale de la batterie détruira les Batteries PHI, provoquera des incendies électriques et Annulera la Garantie.
5. Un mauvais dimensionnement du groupe de batteries.
  - A. Un dépassement du taux de décharge ou de charge maximal des Batteries PHI détruira les Batteries PHI et Annulera la Garantie.
  - B. Se reporter à la Section 3.2 et à l'Annexe B du présent Manuel pour plus d'informations sur la façon de calculer avec précision et correctement la capacité du groupe de batteries PHI. Ne pas suivre ces instructions détruira les batteries

The PHI Battery Warranty does NOT cover product damage caused by mishandling or improper use per the Installation Manual, Integration Guides and Warranty, exposure to liquids, impacts from falling objects or being dropped, or attempts to repair the battery by any party other than SimpliPhi. The complete list of Warranty Exclusions is included in the PHI Battery Warranty document: <https://simpliphipower.com/wp-content/uploads/documentation/ampliphi-series-phi-series/simpliphi-power-ampliphi-battery-phi-battery-warranty.pdf>

## 1.0 – Introduction

### 1.1 – Online Resources

The Product Documentation section of SimpliPhi's web site (<https://simpliphipower.com/product-documentation/>) includes Specification Sheets, Warranties, Installation & Operator's Manuals, and Integration Guides for all SimpliPhi's current products. For information regarding legacy products see Appendix D for battery parameters or contact [techsupport@simpliphipower.com](mailto:techsupport@simpliphipower.com).

SimpliPhi's YouTube channel ([https://www.youtube.com/channel/UCcuCaLT\\_G3Hhumteh-pl5yg/videos](https://www.youtube.com/channel/UCcuCaLT_G3Hhumteh-pl5yg/videos)) has instructional videos showing various steps of the battery installation process in detail.

### 1.2 – Technical Support

SimpliPhi Technical Support (805-640-6700 x 1, [techsupport@simpliphipower.com](mailto:techsupport@simpliphipower.com)) is available to take any questions regarding this manual or general installation questions. For assistance with battery system commissioning, SimpliPhi asks that a commissioning call be scheduled ahead of time with Technical Support.

We encourage you or your installer to contact SimpliPhi with any questions. We are committed to working with you and your installation team to achieve a safe, reliable storage system that will provide years of maintenance-free service that is covered by our Warranty terms & conditions.

### 1.3 – Product Overview

The PHI deep-cycle Lithium Ferro Phosphate (LFP) Battery is optimized with proprietary cell architecture, power electronics, Battery Management System (BMS), manufacturing materials and processes. This assures the highest grade and quality, longest cycle-life, greatest efficiency and freedom from material impurities, toxicity and hazardous risk. The PHI Battery is modular, lightweight and scalable. It provides power security and seamless integration of renewable and traditional sources of energy in conjunction with or independent of the grid.

#### 1.3.1 – Battery Management System (BMS)

Each PHI Battery contains circuitry that protects the LFP cells from overcharge, over-discharge and extreme load amperage. If pre-programmed BMS values are exceeded, the protective circuitry will shut down the flow of electricity to/from the PHI Batteries. In some cases, this will result in the need to re-set the BMS (see Section 6.0 - Troubleshooting of this Manual) and re-initialize an inverter/charger. Often, inverter system settings will be saved within the inverter memory storage and will not need to be reset. However, this is not an absolute standard but is common in most inverter/chargers and should be anticipated if the PHI Batteries go into a state of self-protection and shut down the flow of electricity. Refer to SimpliPhi's Integration Guides for inverter and/or charge controller settings (<https://simpliphipower.com/product-documentation/>).



**CAUTION:** Although each PHI Battery contains an internal BMS with circuitry that protects the PHI Battery cells from over-charge, over-discharge and extreme load amperage, the PHI Batteries must always be installed with appropriate inverter and/or charge controller settings to protect the PHI Battery from open PV voltage and other high voltage charging sources. Exposure to higher voltage than the PHI battery rating will destroy the PHI batteries and Void the Warranty.



**MISE EN GARDE:** Chaque Batterie PHI contient un système de gestion interne (BMS) qui protègent les cellules de Batterie PHI contre une surcharge, une décharge excessive et ampérage trop fort. Cependant les batteries PHI doivent toujours être installées avec les réglages appropriés de l'onduleur et/ou du contrôleur de charge pour protéger la Batterie PHI contre une charge photovoltaïque (PV) à haute tension ou toute autre source à haute tension. Une exposition à une tension supérieure à la tension nominale de la Batterie PHI détruira les batteries PHI et Annulera la Garantie.

### 1.3.2 – Built-In Breaker

PHI batteries with threaded stud connections (such as battery models PHI 3.8-M) are outfitted with a hydraulic/magnetic circuit breaker. This breaker increases safety during shipping and installations and allows the battery to effectively be turned “OFF” or “ON.” The breaker works in conjunction with the battery’s built-in BMS and creates additional safety, efficiency and functionality in the overall power storage system.

Figure 1.0 – PHI 3.8 Circuit Breaker



**NOTE:** Circuit breakers, disconnects and fuses should be employed throughout several points of a power storage and generation installation to effectively isolate and protect all components of the system to safeguard against faults, short circuits, polarity reversals or a failure of any component in the overall system. Fuses, breakers, wiring ratings and values should be determined by established electrical codes and standards and evaluated by certified electricians, licensed installers, and regional code authorities.



## 1.4 – Specifications

Please review Table 1.0 below for PHI Battery specifications, including physical dimensions, Warranty period, and technical data.

**Table 1.0 - PHI Battery Specifications**

	PHI 3.8-M™
	48V
DC Voltages - Nominal	51.2 VDC
Amp-Hours	75 Ah
Rated Capacity	3.8 kWh DC
MAX Discharge Rate (10 minutes)	80 Amps DC (4.1 kW DC)
MAX Continuous Discharge & Charge Rate	37.5 Amps DC (1.92 kW DC)
DC Voltage Range <sup>1</sup>	48 to 56 VDC
Depth of Discharge <sup>1</sup>	up to 100%
Operating Efficiency	98%
Charging Temperature <sup>1</sup>	32° to 120° F (0° to 49° C)
Operating Temperature <sup>1</sup>	-4° to 140° F (-20° to 60° C)
Storage Temperature	6 months: 14° to 77° F (-10° to 25° C) 3 months: -4° to 113° F (-20° to 45° C)
Self-Discharge Rate	< 1% per month
Expected Cycle Life	10,000 cycles @ 80% DOD / 5,000 cycles @ 90% DOD / 3,500 cycles @ 100% DOD
Memory Effect	None
Warranty Period	10 Years
Weight	86 lbs (39 kg) <sup>2</sup>
Dimensions (W x H x D)	13.5 x 14 x 8 in. (15.5" H w/terminals) / 0.88 ft <sup>3</sup> (34.3 x 35.6 x 20.3 cm / 0.025 m <sup>3</sup> )

### Notes:

<sup>1</sup> Max operating ranges. Refer to Warranty for recommended conditions.

- Specifications are typical/nominal. Subject to change without notice.
- There is less than 1% loss of energy during charging.



## 2.0 – Safety

For safety reasons, read all instructions and cautionary markings on the PHI Batteries, and all appropriate sections of this manual. Failure to follow instructions provided in the Installation Manual, Integration Guides and Warranty will Void the Warranty.

### 2.1 – General Safety Instructions

- Do not operate if the PHI Battery has been damaged in any way during shipping or otherwise.
- To reduce the chance of short-circuits, always use insulated tools when installing or working with PHI batteries or other electrical equipment.
- Remove personal metal items such as rings, bracelets, necklaces, and watches when working with PHI batteries and electrical equipment. Wear insulated gloves and rubber shoes.
- PHI Batteries pose some risk of shock or sparking during the installation and initial wiring and connection process. This is consistent with all other battery-based storage formats. For batteries with threaded stud connections, be sure the built-in breaker is in the “OFF” position to minimize the risk of shock or sparks during the installation and commissioning of the system.
- To avoid a risk of fire and electric shock, make sure that existing system wiring is in good condition and that the wire is not undersized. Do not operate the PHI Battery in conjunction with damaged or substandard wiring.

These safety precautions are in addition to the Warnings previously outlined on page 4 of this Manual.

### 2.2 – Response to Emergency Situations

As with any battery, if the PHI Battery’s cells are severely damaged due to physical abuse, reverse polarity, high voltage, unmitigated current or other electrical phenomenon incurred outside of Warranted specifications, it can cause electrolyte leakage and other failures. The electrolyte can be ignited by an open external flame. However, unlike other lithium ion batteries with cobalt oxides (e.g. LCO, NCM and NCA), the PHI LFP Batteries’ electrolyte and other material components generate a limited amount of heat and do not go into a state of thermal runaway with fire propagation. The SimpliPhi UL 1973 Battery Certification verifies “No Thermal Runaway” (see MSDS for chemical analyses).

While PHI Batteries do not go into thermal runaway with fire propagation, the following protocol should be followed in the event that the PHI batteries are subjected to electrical fire caused by other system components or failures:

- Ensure that the system is no longer energized, either from the solar array or the grid (main disconnect).
- Separate any external cables from batteries if present (cut if necessary) using insulated tools.
- Wear a respirator or dust mask to avoid inhaling soot/dust.
- Wear insulating and abrasion-resistant gloves (if permeable, over nitrile or similar gloves).
- Move battery debris into non-conductive bins capable of handling the weight.
- Dispose as regulations require.



**CAUTION:** While water is an acceptable and effective extinguishing agent for the PHI Core Power and Peak Power Battery models, the Balance of System equipment used in conjunction with the PHI Batteries may require specialized extinguishers such as FM-200 or CO2 suppression systems.



**MISE EN GARDE:** Bien que l’eau puisse être un extincteur naturel acceptable et efficace pour les modèles de batteries PHI Core Power et Peak Power, l’équipement du Système Equilibré Utilisé conjointement avec les Batteries PHI peut nécessiter l’utilisation d’extincteurs spécialisés tels que le FM-200 ou autre systèmes de suppression de CO2.

## 3.0 – Pre-Installation

### 3.1 – PHI Battery Performance

PHI Batteries do not need to be de-rated unless running continuously at more than 90% capacity, at temperatures below 32° F (0° C), or above 113° F (45° C). To achieve the greatest cycle life of 10,000 cycles, PHI Batteries are typically operated at 80% maximum Depth of Discharge.

All PHI Batteries are balanced during final production and testing stages. Following proper wiring guidelines ensures that a system will not require any manual balancing processes.

### 3.2 – PHI Battery System Sizing

PHI Batteries are designed to operate at the continuous ratings specified in Table 1.0 – PHI Battery Specifications. Therefore, a properly sized PHI Battery bank must be sized to handle both the inverter’s “load rate” as well as the maximum potential charge rate from the solar photovoltaic (PV) array. Take care to consider not only the energy (kWh) requirement of the battery bank, but also all other power-related sizing parameters, as outlined in Sections 3.2.1, 3.2.2 or 3.2.3 and 3.2.4. Failure to do so will Void the Warranty.



**CAUTION:** PHI Battery bank sizing not in accordance with the following sections will damage the PHI batteries and Void the Warranty



**MISE EN GARDE:** Un mauvais dimensionnement du groupe de Batteries PHI et non conforme aux sections suivantes endommagera les Batteries PHI et Annulera la Garantie.

#### 3.2.1 – Sizing for Maximum Instantaneous Discharge (Load Rate)

The load rate is the amount of power that is discharged from the battery bank to the loads. This may include both alternating current (AC) and/or direct current (DC) loads. PHI Battery banks are sized so that the batteries’ combined maximum continuous discharge rate meets or exceeds the load rate.

$$\text{PHI Battery Bank MAX continuous discharge rate kW DC} \geq (\text{Inverter DC Load Rate}) + (\text{DC Loads, if any})$$

Because most loads are AC loads, the load rate is typically represented by the inverter’s AC Power Output rating. Convert the inverter’s maximum potential AC power draw to the maximum potential DC power draw from the battery bank by factoring in the inverter’s efficiency rating.

$$\text{Inverter DC Load Rate} = (\text{Inverter power rating kW AC}) \div (\text{Inverter efficiency})$$

**Example:** An inverter rated at 5 kW AC and 92% efficiency potentially draws 5.4 kW DC from the battery bank.

$$\text{Inverter DC Load Rate} = (5 \text{ kW AC}) \div (0.92) = 5.4 \text{ kW DC}$$

If the system includes DC Loads, no AC-to-DC conversion is necessary. Calculate the minimum quantity of PHI Batteries needed to ensure that the battery bank does not over-discharge by dividing the load rate by the MAX Continuous Discharge Rate per PHI Battery (found in Table 1.0 or on the relevant battery’s specification sheet).

$$\begin{aligned} & (\text{Load Rate}) \div (\text{MAX Continuous Discharge Rate per Battery}) \\ & = \text{Minimum Battery quantity to prevent overdischarge} \end{aligned}$$

**Example, continued:** Three PHI 3.8 kWh batteries must be paired with an inverter rated at 5 kW AC and 92% efficiency to ensure the PHI Battery bank does not over-discharge to power the loads.

$$(5.4 \text{ kW DC}) \div (1.92 \text{ kW DC}) = 2.83 \text{ --> round to 3}$$

Refer to the Battery Bank Sizing for Maximum Instantaneous Discharge (Load Rate) tables in Appendix B of this Manual for a complete list of common battery-based inverters and the minimum quantity of PHI Batteries those inverters need to be paired with to ensure that the PHI Battery bank does not over-discharge. Over-discharging the PHI Batteries will destroy them and Void the Warranty.

In the case where the inverter’s AC Power Output rating exceeds the connected loads’ actual power draw (i.e. the inverter is rated at 5 kW but all loads amount to 3 kW of maximum instantaneous power draw), **SimpliPhi still expects that the proper additional precautions be made to ensure that the PHI Battery bank is not over-discharged.** Failure to do so will destroy the PHI batteries.

### 3.2.2 – Sizing for Maximum Instantaneous Charge Rate (DC Coupled)

In a DC Coupled system, the solar PV array output can be mitigated using charge controllers. However, reducing the solar array’s power output using charge controller programming implies that the PV array’s output is also reduced for the entire remainder of the system, including the solar power available for powering loads and for exporting to the grid. Furthermore, greatly reducing the PV array’s output via the charge controllers effectively wastes the solar PV array’s power and puts strain on the charge controllers.

Calculate the minimum quantity of PHI Batteries needed to prevent over-charge from the solar PV array by considering both the solar array size and the charge controller’s potential output. Whichever value is less should be used to size the PHI Battery Bank. If the solar array’s maximum potential current output is less than the paired charge controller’s Output Amps rating, then the solar array’s maximum potential current output can be used to size the PHI Battery bank. If the charge controller’s Amp rating is less than the solar array’s maximum potential current output, then the charge controller’s rating is used to size the PHI Battery bank.

Divide the system’s potential charging current by the MAX Continuous Charge Rate per PHI Battery (found in Table 1.0 or on the relevant battery’s specification sheet) to calculate the minimum quantity of PHI Batteries needed to ensure that the solar PV array does not over-charge the battery bank.

**Example:** Three PHI 3.8 kWh-51.2V<sub>nominal</sub> batteries must be paired with a 4,500-Watt solar PV array wired to an 80 Amp-rated charge controller. In this case, the 80-Amp charge controller is used to determine the minimum PHI Battery quantity needed to prevent over-charging from the solar PV.

$$\text{Watts} = \text{Amps} \times \text{Volts}$$

$$4,500 \text{ Watt Solar PV Array} = \text{Amps} \times 48 \text{ Volts}$$

$$\frac{(4,500 \text{ Watts})}{(48 \text{ Volts})} = 93.75 \text{ Amps} = \text{MAX potential solar PV array output}$$

$$80 \text{ Amps} < 93.75 \text{ Amps --> } \mathbf{80 \text{ Amps}}$$

$$= \text{MAX potential solar PV array output through the charge controller}$$

$$(\text{MAX potential charging current}) \div (\text{MAX Charge Rate per Battery})$$

$$= \text{Minimum Battery quantity to prevent overcharge}$$

$$(80\text{A}) \div (37.5\text{A}) = 2.13 \text{ --> round to 3}$$

**Example B:** Three PHI 3.8 kWh-51.2V<sub>nominal</sub> batteries must be paired with a 3,000-Watt solar PV array wired to a 100 Amp-rated charge controller. In this case, the 3,000-Watt solar array is used to determine the minimum PHI Battery quantity needed to prevent over-charging from the solar PV.

$$\text{Watts} = \text{Amps} \times \text{Volts}$$

$$3,000 \text{ Watt Solar PV array} = \text{Amps} \times 48 \text{ Volts}$$

$$\frac{(3,000 \text{ Watts})}{(48 \text{ Volts})} = 62.5 \text{ Amps} = \text{MAX potential solar PV array output}$$

$$62.5 \text{ Amps} < 100 \text{ Amps} \rightarrow 62.5 \text{ Amps}$$

= MAX potential solar PV array output through the charge controller

$$\frac{(\text{MAX potential charging current})}{(\text{MAX Charge Rate per Battery})}$$

= Minimum Battery quantity to prevent overcharge

$$(62.5\text{A}) \div (37.5\text{A}) = 1.66 \rightarrow \text{round to } 2$$

Refer to the Battery Bank Sizing for Maximum Instantaneous Charge Rate tables in Appendix B of this Manual for a complete list of common charge controllers and the minimum quantity of PHI Batteries those controllers need to be paired with to ensure that the PHI Battery bank does not over-charge (assuming that the charge controllers' full current output rating is utilized). Failing to do so will destroy the PHI batteries and Void the Warranty.

### 3.2.3 – Sizing for Maximum Instantaneous Charge Rate (AC Coupled)

In an AC Coupled system, charge controllers do not regulate the PV solar array's output, and many battery-based inverters fail to effectively regulate the array's output for battery charging. Therefore, in an AC Coupled system, SimpliPhi assumes that all the connected PV array's potential power output will charge the system's batteries. Determine the minimum quantity of PHI Batteries needed to prevent over-charge from the solar PV array by dividing the solar array's power rating by the MAX Continuous Charge Rate per PHI Battery (found in Table 1.0 or on the relevant battery's specification sheet).

**Example:** Four PHI 3.8 kWh-51.2V<sub>nominal</sub> batteries must be paired with 6 kW of AC Coupled solar PV to ensure the PHI Battery bank does not over-charge from the solar array.

$$(6 \text{ kW}) \div (1.92 \text{ kW}) = 3.13 \rightarrow \text{round to } 4$$

### 3.2.4 – Overall Battery System Sizing

Size the PHI battery bank so that the minimum number of batteries in the bank is the greater of the two figures obtained from the Discharge and Charge calculations. For example, a system that requires 5 PHI Batteries to ensure that the battery bank does not over-discharge and 3 PHI Batteries to ensure that the battery bank does not over-charge, should include a final minimum quantity of 5 batteries. Failure to do so will destroy the PHI batteries and will Void the Warranty.

Note that this quantity of PHI Batteries is the minimum requirement to prevent over-discharge and over-charge from an instantaneous power perspective. The system may need more PHI Batteries in the battery bank in order to meet the system's energy requirement (the amount of power the batteries must supply to the loads over time).

Refer to SimpliPhi's online Battery Bank Sizing Estimator tool for assistance with sizing the PHI Battery Bank according to connected loads and the desired number of days of autonomy: <https://simpliphipower.com/support/battery-bank-sizing-estimator/>.



**CAUTION:** Not all system discharge or charge characteristics can be mitigated via programming. Undersizing a PHI Battery bank relative to the system's maximum discharge or charge rate will destroy the PHI Batteries and Void the Warranty.



**MISE EN GARDE:** Tous les systèmes de décharge ou de charge ne peuvent pas être modifiés par une programmation. Un mauvais dimensionnement du groupe de Batteries PHI par rapport à la décharge maximale ou du taux de charge du système, détruira les Batteries PHI et Annulera la Garantie.

## 4.0 – Installation

### 4.1 – Installation Options

The PHI 3.8 Battery can be mounted in practically any orientation (terminals up or on any side), with no impact to the performance of the PHI Battery. Do not install the battery upside down, with the terminals facing the floor.

### 4.2 – Environmental Considerations

#### 4.2.1 – Charging at Temperatures Below Freezing

It is important to take necessary steps to determine the temperature of the PHI Battery prior to charging the battery, as the battery may otherwise be adversely impacted.



**CAUTION:** Do not attempt to charge the PHI Battery below 32° F (0° C). Attempts to charge at subfreezing temperatures can adversely affect SOH and cycle life and will Void the Warranty.



**MISE EN GARDE:** Ne pas charger la Batterie PHI en dessous de 0° C (32° F). Tout chargement à des températures de congélation peuvent nuire à l'état de santé et la durée de vie de la batterie, et Annuleront la Garantie.

#### 4.2.2 – Explosive Gas Precautions

PHI Batteries are not ignition protected. To prevent fire or explosion, do not install this product in locations that require ignition-protected equipment. This includes any confined space containing vented batteries, or flammable chemicals such as, natural gas (NG), liquid petroleum gas (LPG) or gasoline (Benzine/Petrol).

Do not install in a confined space with machinery powered by flammable chemicals, or storage tanks, fittings, or other connections between components of fuel or flammable chemical systems.

PHI Batteries do not vent any harmful gasses and do not require special ventilation or cooling.

#### 4.2.3 – Anti-Corrosion Protection

Anticorrosive compounds or epoxies are occasionally used in harsh or marine climate installations. Please consult your electrician or qualified installer to determine if this is advisable, and if so, what solution best suits your application.



**CAUTION:** Do not combine PHI Batteries with other brands or chemistries. Do not mix PHI Batteries from different installations, clients or job sites. Either of these combinations will Void the Warranty.



**MISE EN GARDE:** Ne pas associer les Batteries PHI avec d'autres marques et/ ou autres produits chimiques. Ne pas mélanger les Batteries PHI provenant de différentes installations, différents clients ou différents sites de travail. L'un ou l'autre de ces mélanges Annulera la Garantie.

### 4.3 – Mounting Hardware

PHI Battery mounting brackets (sold separately) are designed to secure one PHI 3.8 Battery to a load bearing surface. The brackets can be mounted directly to a wall or can be arranged on strut channels for ease of positioning (mounting hardware not included). Mounting brackets should be mounted into load bearing beams, studs or solid materials with appropriate fasteners. A qualified installer should be familiar with accomplishing this with the appropriate load bearing requirements. SimpliPhi Power is not liable for damage caused by inappropriate installation mounting of brackets. Refer to Figure 2.0 for PHI Battery and mounting bracket dimensions and weights.

During mechanical testing, individual PHI 3.8 Mounting Brackets were exposed to 200 pounds each of downward pressure along the bracket's outer edge. During this test, a deflection of approximately 30 thousandths of an inch was measured. Bracket sets are designed to hold one PHI 3.8 Module with a weight of 86 pounds.

### 4.4 – Dimensions and Weight

Table 3.0 – Specifications: PHI 3.8 Battery & PHI 3.8 Battery w/ Mounting Bracket

	PHI 3.8 Battery	PHI 3.8 Battery/ w/ Mounting Bracket
Width	13.5"	13.7" (18" with mounting flanges)
Height	15.5" (including 1.5" terminal height)	15.75" (including 1.5" terminal height)
Depth	8"	9"
Weight	86 Pounds	94 pounds

Figure 2.0 – PHI 3.8 Mounting Bracket Assembly

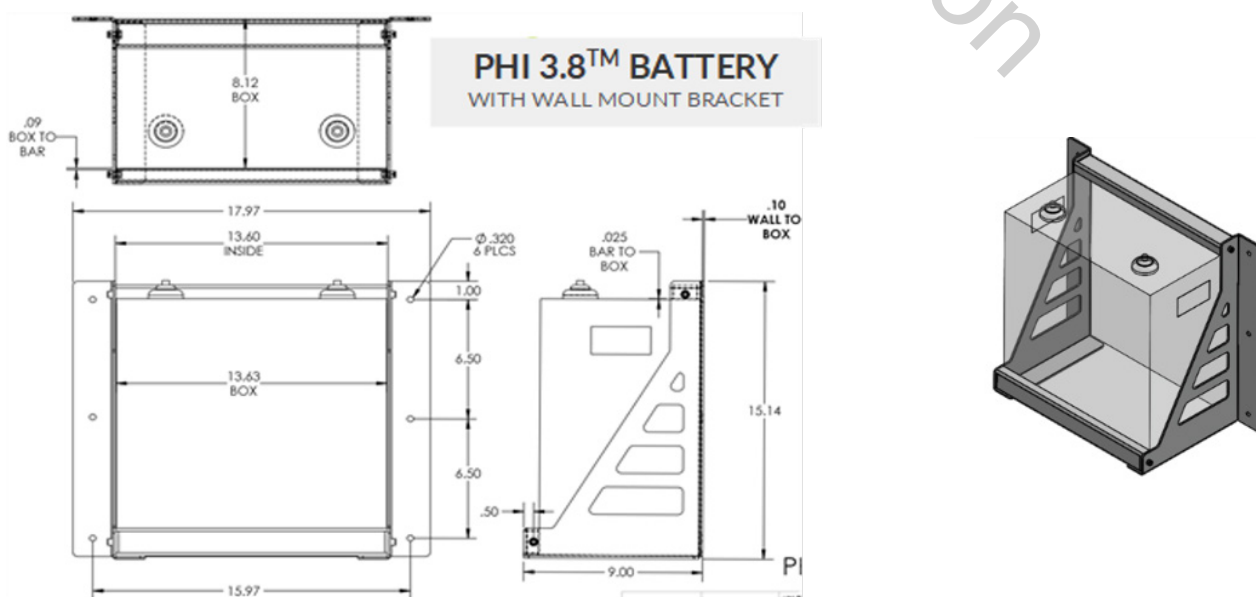

## 4.5 – PHI Battery Connection Terminals

### 4.5.1 – Batteries with Threaded Studs

The PHI 3.8 Battery is equipped with two 3/8" (10 mm) threaded studs with a lock washer and nut. The red colored high temperature molded insert connection is for the positive lead. The black colored high temperature insert connection is for the negative lead.

Water Resistant Cable Boots are also included and will be in place when your units arrive. The boots are to be placed over the cable terminations and will stretch to form a water-resistant seal around the base of the molded inserts and terminal connections.



**CAUTION:** Do not attempt to loosen the large brass nut at the base of the terminals; doing so will damage the PHI battery and Void the Warranty.



**MISE EN GARDE:** Ne pas desserrer le gros écrou en laiton à la base des bornes; cela endommagerait la Batterie PHI et Annulerait la Garantie.

### 4.5.2 – Torque Value for Batteries with Threaded Studs

PHI Batteries with threaded stud terminals have a torque specification of 160 in-lbs. (13.3 ft-lbs.).

Figure 3.0 – PHI 3.8-M Threaded Stud



Threaded Studs = 3/8" (10mm)  
Torque Value = 160 in-lbs



## 4.6 – Wiring



**CAUTION:** All PHI Batteries are designed to serve at fixed voltages and cannot be wired in series to increase the battery bank's voltage. Wiring the PHI Batteries in series will result in damage to the PHI Battery's protective circuitry and will Void the Warranty. PHI batteries are designed for parallel wiring only to increase the battery bank's storage capacity.



**MISE EN GARDE:** Toutes les Batteries PHI sont conçues pour performer à des tensions fixes et ne peuvent pas être câblées en série pour augmenter la tension de la batterie. Le câblage des Batteries PHI en série endommagera les circuits de protection interne de la Batterie PHI et Annulera la Garantie. Les Batteries PHI sont conçues uniquement pour un câblage en parallèle, cela pour augmenter la capacité de stockage de la batterie.

### 4.6.1 – Increasing Storage Capacity via Parallel Wiring

Storage Capacity and total available Amperage is increased incrementally with the number of units wired in Parallel. For example, two PHI 3.8 kWh-51.2Vnominal (75Ah) Batteries wired in parallel are rated at a combined 7.6 total kWh, 51.2 Volts DC and 150Ah. Each PHI 3.8 kWh-51.2Vnominal Battery also has a maximum continuous discharge rate of 37.5 Amps DC and paralleling two of these batteries incrementally increases the maximum continuous charge and discharge rate. The two paralleled PHI 3.8 kWh-51.2Vnominal batteries have a combined maximum continuous charge and discharge rate of 75 Amps DC ( $2 \times 37.5ADC$ ).

### 4.6.2 – Parallel Wiring Batteries with Threaded Studs using Battery Cables

PHI Batteries are paralleled by wiring from individual PHI Batteries to DC busbars or plates, which may be located in a DC combiner box or the inverter's power panel.

Figure 4.0 – Two PHI Batteries in Parallel

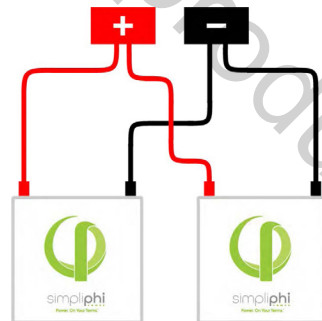

Although lead acid batteries are typically wired using battery-to-battery interconnecting cables, SimpliPhi asks that PHI Batteries NOT be wired in this way.

Figure 5.0 – Incorrect PHI Battery Wiring

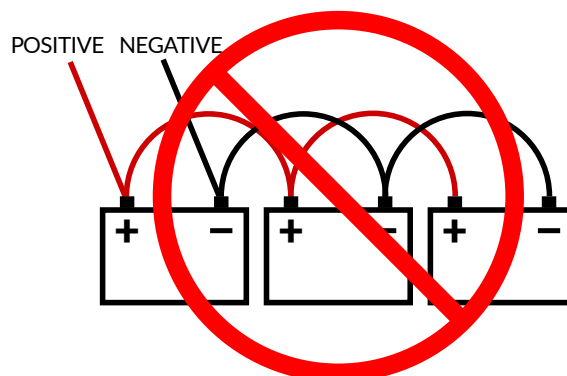



**CAUTION:** Identical wire lengths and identical wire gauges from each PHI Battery in a PHI Battery bank is a critical feature of parallel power storage systems that must be adhered to throughout all parallel wiring instructions. Failure to properly wire the PHI Batteries in parallel will Void the Warranty.



**MISE EN GARDE:** Impérativement respecter toutes les instructions de câblage en parallèle. Il est important de noter que chaque fil, relié aux Batteries PHI dans un groupe de batteries, soit d'une longueur et d'une taille identique. Un mauvais câblage des Batteries PHI en parallèle Annulera la Garantie.

Figure 6.0 depicts four PHI Batteries wired in Parallel. This configuration requires 8 identical lengths of identical gauge copper wire.

Figure 6.0 - Four PHI Batteries in Parallel

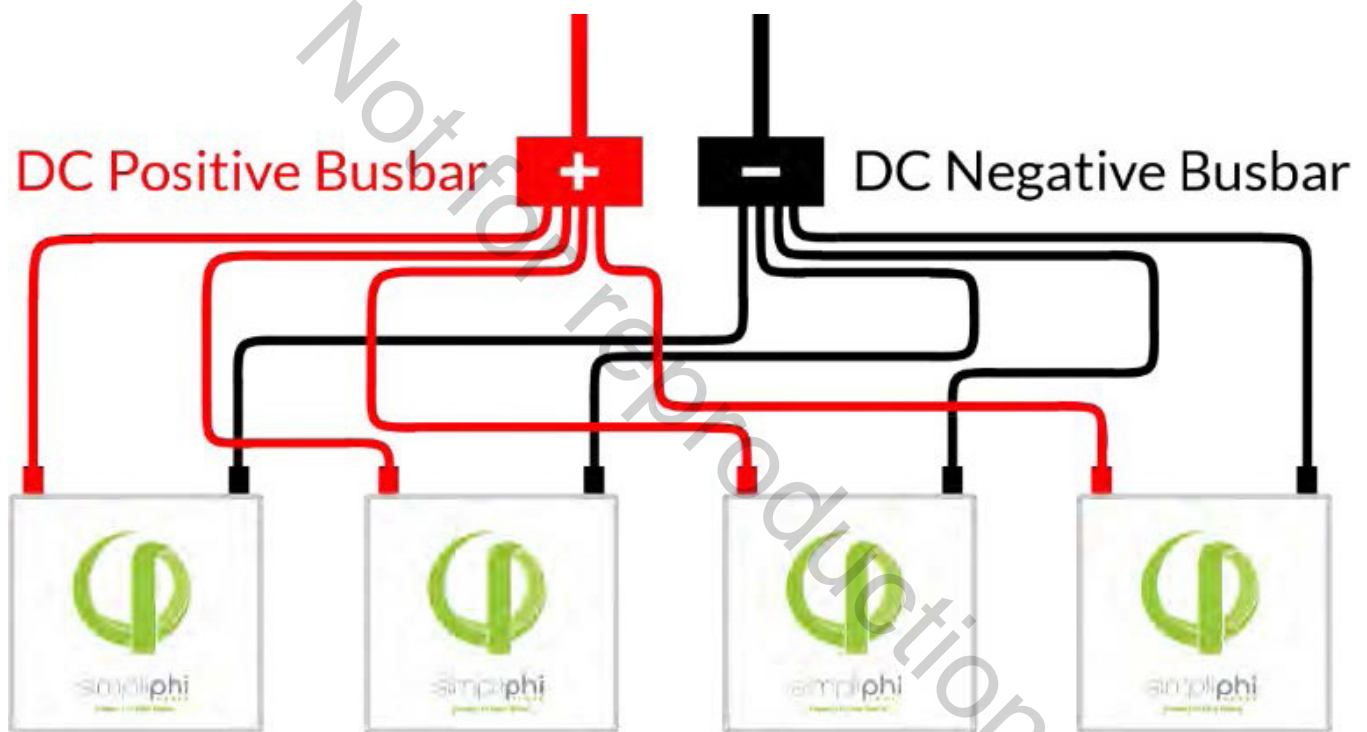

## Helpful Tips:

- SimpliPhi's complete wiring guide can be found at this link: <https://simpliphipower.com/wp-content/uploads/documentation/phi-series/simpliPhi-power-phi-series-batteries-threaded-terminal-wiring-guide.pdf>
- Power cabling for paralleling PHI Batteries is not included. All wire should be an appropriate gauge and construction to handle the loads that will be placed upon it. Heavy gauge, high strand copper wire is the industry standard due to its stability, efficiency and overall quality.
- Each PHI Battery's individual wire runs are typically sized at **4 AWG**, according to the 80A built-in breaker.
  - Conductor ampacity can be determined using National Electrical Code tables.
  - Depending on the electrical code of the local Authority Having Jurisdiction, the PHI Battery leads' gauge may need to be sized according to the built-in breaker or according to the PHI Battery's surge rating.
- Battery cables can be custom ordered to include the **3/8" lugs** that fit on the PHI Battery's threaded studs.
- Determine the cable length for the PHI Battery terminal farthest from the common busbar or plate first.
- Additional cabling or slack that remains with the shorter distance runs can be coiled and secured with Zip Ties.
- Wire length should be kept as short as practical.
- Positive wire runs should be separated from negative wire runs in separate conduit.
- Energy supplied by the PHI Battery is reduced as electrical current moves through wire. For lengths of battery cable greater than ~10 feet (3 meters), ensure that the voltage drop is no greater than 3%.
- To take full advantage of the combined PHI Battery bank's surge rating, the DC busbars or plates that the individual PHI Batteries are wired to should be rated to match the PHI Battery bank's total surge rating.
- MidNite Solar produces the [MNLB Lithium Battery Combiner](#) (rated at 250 Amps MAX) and the [MNBCB 1000/50 Battery Combiner](#) (rated at 1,000 Amps MAX)



**CAUTION:** Do not reverse polarity. Positive battery cables must connect to the PHI Battery's Positive terminal studs and to Positive DC busbars or plates. Negative battery cables must connect to the PHI Battery's Negative terminal studs and to Negative DC busbars or plates. Reversing polarity will Void the Warranty.



**MISE EN GARDE:** Ne pas inverser la polarité. Les câbles positifs de la batterie doivent être raccordés aux bornes Positives de la Batterie PHI et au jeu de barres ou plaques CC Positives. Les câbles de la batterie Négative doivent être raccordés aux bornes Négatives de la Batterie PHI et au jeu de barres ou plaques CC Négatives. Inverser la polarité Annulera la Garantie.

Figure 7.0 – Lug Placement on PHI Battery Threaded Stud

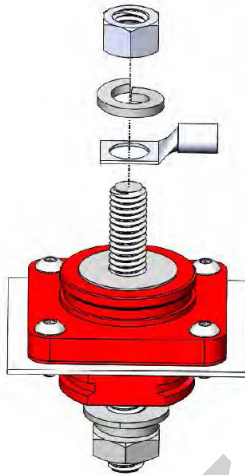

**CAUTION:** No material (such as a washer) should be placed between the current carrying terminal and the cable lug or interconnecting busbar. Doing so will Void the Warranty.



**MISE EN GARDE:** Aucune pièce (comme une rondelle) ne doit être placée entre la borne de transport de courant et la cosse de câble ou bien le jeu de barres d'interconnexion. Cela Annulera la Garantie.



**CAUTION:** Spark may be present when connecting wires to PHI battery terminals. Be sure the battery's built-in circuit breaker is in the OFF position to minimize the risk of shock or sparks during system installation.



**MISE EN GARDE:** Une étincelle peut apparaître lors de la connexion des fils aux bornes de la Batterie PHI. Assurez-vous que le disjoncteur intégré à la batterie est en position OFF pour minimiser le risque de choc ou d'étincelles lors de l'installation du système.

### 4.6.3 – Parallel Wiring Batteries with Threaded Studs using Interconnecting Busbars

PHI Batteries can be paralleled using common bussing directly attached to the batteries' terminals. Best practice involves wiring the battery leads to opposite ends of the busbars, as illustrated in Figure 8 below. Interconnecting busbars for paralleling either two (SKU #BB-2) or three (SKU #BB-3) PHI batteries with threaded studs are available from SimpliPhi at an additional cost.

Figure 8.0 - PHI Battery Wiring Using Interconnecting Busbars

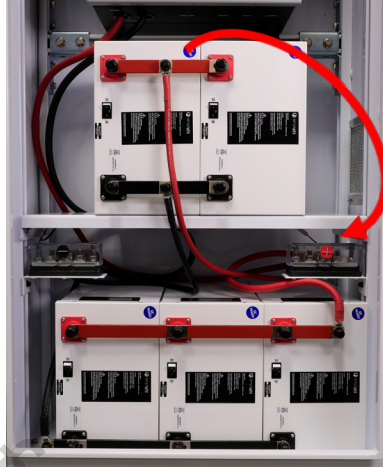

**CAUTION:** Again, no material (such as a washer) should be placed between the current carrying terminal and the interconnecting busbars. The interconnecting busbars are placed on the PHI Batteries' terminals first, then the flat washer, lock washer, and nut are secured to the terminal posts



**MISE EN GARDE:** Encore une fois, aucune pièce (comme une rondelle) ne doit être placée entre la borne de courant et la cosse du câble, ou bien le jeu de barres. Le jeu de barres d'interconnexion sont d'abord placées sur les bornes des Batteries PHI, puis la rondelle suivi de la rondelle d'arrêt et enfin de l'écrou, le tout fixé à la borne.

Figure 9.0 - Interconnecting Busbar Placement on PHI Battery Threaded Stud

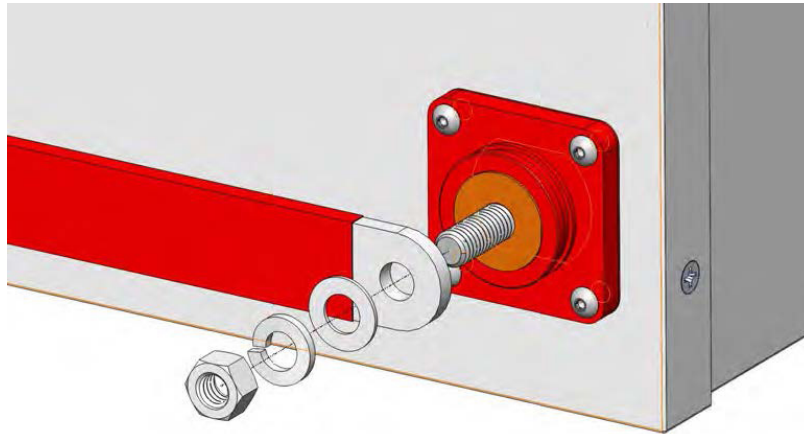

**Helpful Tips:**

- The interconnecting busbars' ratings should match or exceed the PHI Battery bank's total surge rating.
- Busbars for paralleling more than two or three PHI Batteries can be sourced from Storm Power Components: <https://stormpowercomponents.com/>.
- SimpliPhi recommends paralleling PHI Batteries using interconnecting busbars (not battery cables) for PHI Battery Banks consisting of more than 20 PHI Batteries for a cleaner installation.
- Size the battery cables leading from the interconnecting busbars to the Balance of System equipment using the National Electrical Code's Conductor Ampacity tables.



**CAUTION:** Do not reverse polarity. Use a voltmeter to check polarity before making connections to the battery terminals. Reversing polarity will Void the Warranty.



**MISE EN GARDE:** Ne pas inverser la polarité. Utiliser un voltmètre pour vérifier la polarité avant de se connecter aux bornes de la batterie. Inverser la polarité Annulera la Garantie.

## 4.7 – Battery System Commissioning



**CAUTION:** PHI Batteries should be installed, wired and commissioned by a certified installer or professional electrician who is familiar with general electrical safety precautions and specific regional code requirements.



**MISE EN GARDE:** Les Batteries PHI devraient être installées, câblées et mises en service par un installateur agréé ou un électricien professionnel qui connaît les mesures de sécurité électriques générales et les exigences particulières du code régional.

If the PHI Battery's voltage has dropped (during an extended period in storage) to a voltage below the inverter's minimum starting voltage requirement, then the battery will need to be charged using a plug-in / external charger. SimpliPhi's batteries have a very low self-discharge rate and typically do not require ancillary charging. If the PHI Battery's voltage has dropped due to over-discharge, try the steps outlined in Section 6.0 – Troubleshooting prior to using ancillary charging equipment.



**CAUTION:** Only use a SimpliPhi approved LFP charger if ancillary charging is required before installation, testing or troubleshooting. Failure to use a SimpliPhi approved LFP charger will damage the PHI Batteries and Void the Warranty. See Appendix C for more details on approved chargers.



**MISE EN GARDE:** Uniquement utiliser un chargeur LFP approuvé par SimpliPhi si une charge auxiliaire est nécessaire avant l'installation, une mise à l'essai ou un dépannage. Ne pas utiliser un chargeur LFP approuvé par SimpliPhi endommagera les Batteries PHI et Annulera la Garantie. Voir l'Annexe C pour plus de détails sur les chargeurs approuvés.

1. Before installing the PHI Battery, inspect the battery for any signs of damage. Do not install or operate the battery if it has been damaged during shipping.
2. Prepare the battery module for installation by removing its plastic terminal covers, 11/16" stainless steel hex nuts and 3/8" lock washers from the battery terminals and set aside.



**CAUTION:** Do not attempt to loosen the large brass nut at the base of the terminals; doing so will damage the PHI battery and Void the Warranty.



**MISE EN GARDE:** Ne pas desserrer le gros écrou en laiton à la base des bornes ; cela endommagerait la Batterie PHI et Annulerait la Garantie.

3. Before installing the PHI Battery, test its voltage by turning its built-in breaker to the ON (I) position.
4. Measure the PHI Battery's voltage with a multimeter. Batteries typically ship at 20% State of Charge, which correlates with ~50.2 VDC.
5. When installing more than one PHI Battery, check that the batteries' voltage readings are similar. Batteries with a voltage variance greater than 1 Volt DC should be isolated and charged separately.
6. After testing the PHI Battery's voltage, turn the battery's built-in circuit breaker back to the OFF (0) position.
7. Wire the PHI Battery bank with all the included PHI Batteries' built-in breakers in the OFF (0) position.



**CAUTION:** All SimpliPhi Power Core Power and Peak Power products are designed to work exclusively in parallel. Never connect in series to achieve higher voltages. Wiring in series will destroy the PHI batteries and Void the Warranty.

Verify polarity at all connections before energizing system. Reverse polarity at the PHI Battery terminals will destroy the PHI batteries and Void the Warranty.





**MISE EN GARDE:** Tous les produits SimpliPhi Power Core Power et Peak Power sont conçus pour fonctionner exclusivement en parallèle. Ne jamais les connecter en série pour obtenir une tension plus élevée. Le câblage en série détruira les Batteries PHI et Annulera la Garantie.

Vérifier la polarité de tous les branchements avant de mettre le système sous tension. Une polarité inverse aux bornes de la Batterie PHI détruira les batteries PHI et Annulera la Garantie.

8. Confirm all loads are turned OFF. Disconnect the inverter's AC Output breaker or turn off the breaker at the top of your loads' breaker panel.
9. The main DC disconnect in the inverter's power panel should still be in the OFF position.
10. Turn all battery circuit breaker switches to the ON (I) position.
11. Turn the main DC disconnect in the inverter's power panel ON.
12. At this point, the inverter may come on automatically in standby mode, or the inverter might need to be manually turned on.
13. Program the Balance of System Equipment (inverter and/or charge controller) to SimpliPhi's settings, as specified in the relevant Integration Guide (<https://simpliphipower.com/product-documentation/>) and generally outlined in Section 5.0 – Programming of this Manual.



**CAUTION:** SimpliPhi Batteries must operate in conjunction with properly programmed Balance of System equipment. Operating the batteries with equipment that has not been programmed to SimpliPhi's specified parameters will damage the PHI batteries and Void the Warranty



**MISE EN GARDE:** Les Batteries SimpliPhi doivent fonctionner en accord avec une programmation appropriée du Système Equilibré. Un fonctionnement des batteries avec un équipement qui n'a pas été programmé selon les paramètres spécifiés par SimpliPhi endommagera les Batteries PHI et Annulera la Garantie.

14. Charge the batteries fully. When first commissioning the battery system, the batteries must be charged fully before connecting any loads. Neglecting to charge the batteries fully when first commissioning the battery system will Void the Warranty.



**CAUTION:** Remember that charging the batteries in sub-freezing conditions will Void the Warranty.



**MISE EN GARDE:** Charger les batteries à une température inférieure à 0° C (32° F) Annulera la Garantie.

15. Battery charging may be accomplished via the inverter/charger using an AC power source such as the grid or a generator, or via a charge controller using power from a connected solar PV array.
16. The batteries will bulk charge to 56 VDC, will Absorb for 6 minutes (0.1 hours), and will then rest at approximately 53.3 VDC. At this point in the charging cycle, these voltages (53.3V / 26.7V / 13.3v) are considered 100% SOC.
17. Once the batteries are fully charged, turn on the inverter's AC Output breaker and/or the breaker at the top of your loads' breaker panel.

## 4.8 – Battery Bank Expansion

New SimpliPhi Batteries that are added to an existing SimpliPhi battery bank must be of the same nameplate voltage and form factor. If higher capacity PHI batteries are added, such as PHI 3.8-M to a bank of PHI 3.5, the battery bank's total energy capacity for system sizing calculations is the sum of the original battery capacity rating (3.5) multiplied by the new total number of PHI batteries. Therefore, the capacity rating of the original 3.5 PHI batteries determines the capacity rating for the newer PHI 3.8-M battery once installed with the original battery bank. For example, a battery bank composed of two PHI 3.5 batteries and one PHI 3.8-M battery has a total energy storage capacity for system sizing calculations of 10.5 kWh for the bank (3 X 3.5 kWh= 10.5 kWh total). In addition, the Warranty for the new, additional PHI 3.8-M battery adopts the Warranty and Warranty period for the original bank of PHI 3.5 batteries.



**CAUTION:** Do not combine PHI Batteries with other brands or chemistries. This will Void the Warranty.



**MISE EN GARDE:** Ne pas mélanger les Batteries PHI avec d'autres marques ou autres produits chimiques. Cela Annulera la Garantie.

Consult SimpliPhi Power Technical Support if you wish to expand a SimpliPhi battery bank.

In addition to adhering to all other Installation Manual instructions, refer to the following guidelines when expanding upon an existing SimpliPhi battery bank:

1. Charge the existing battery bank ("Bank A") according to normal charging procedure (48V PHI batteries charge to 56V and "rest" at approximately 52.5 - 53.5V after being taken off a charge).
2. Disconnect Bank A from the system, by either
  - A. Disconnecting all battery cables leading from Bank A's batteries to the battery combiner box, panelboard, or inverter's power panel, OR
  - B. Turning off the 80A breakers included in each of Bank A's batteries
3. Connect the additional batteries (Bank B) to the system, following all wiring instructions and torque specifications outlined in previous sections of segment 4.0 in this manual.
4. Modify the settings in the system's inverter/charger(s) or charge controller(s), whichever device will be used to initially charge Bank B.
  - A. Adjust the charge rate in accordance with the number of batteries in Bank B
5. Charge Bank B fully, making sure all loads are disconnected at the time of initial charge
6. Wire all Bank A batteries and Bank B batteries in parallel, adhering to the wiring methods outlined in Section 4.3 above.
  - A. Ensure that DC Positive common bus and DC Negative common bus ratings are appropriate for the new larger quantity of batteries in the bank.
7. Reprogram all inverter/charger and/or charge controller equipment for the new larger battery bank capacity.
  - A. New charging current parameters for the expanded bank should be appropriate for the oldest included PHI battery model. For example, a battery bank composed of one PHI 3.5 battery with a maximum continuous charge rate of 34 Amps DC and one PHI 3.8-M battery with a maximum continuous charge rate of 37.5 Amps DC has a combined maximum continuous charge rate of 68 Amps DC (not 71.5 Amps DC).

# 5.0 – Programming

## 5.1 – Operating Parameters Related to Cycle Life

To maintain optimal PHI Battery health and longevity, adhere to the operating parameters outlined in Tables 5.0 and 6.0 below. Refer to the manufacturer-specific Integration Guide from SimpliPhi's Product Documentation web page for a complete list of settings: <https://simpliphipower.com/product-documentation/>.

Table 5.0 – Optimal Operation Parameters

Recommended Operating Conditions for 10 Year Warranty			
Equivalent to 80% Retained Capacity	10,000 cycles	5,000 cycles	3,500 cycles
Depth of Discharge (DoD)	80%	90%	100%
Operating Temperature °F (°C)	32 to 120 (0 to 49)		
Programming Settings for Ancillary Equipment	48V		
Low Battery Cut-Off Voltage (V)	50.2	49.6	48
Absorb / Charging Voltage	56V		
Absorb Time	6 minutes (0.1 Hours)		
Absorb End Amps (if applicable)	2% of the PHI Battery bank's total Ah capacity		

Table 6.0 – Operating Limitations

Notes / Operating Limitations for PHI Batteries	
	PHI 3.8-M
Minimum Operating Voltage	48V
Continuous Discharge Rate (ADC)	37.5
Surge Discharge Rate (ADC) – 10 minutes maximum	80
Continuous Charge Rate (ADC)	37.5

- Levels are typically @ 25°C and may need adjusting at temperature extremes.
- When performing rapid deep charge/discharge cycles, the PHI Battery should be allowed to “rest” 15 mins in between.

Although the PHI battery charges to the voltages outlined above, the battery “rests” at approximately 53.3V. Refer to Table 6.0 below for a complete Battery Voltage versus State of Charge (SOC) gauge.

Table 7.0 – Voltage/SOC correlation under load

SOC	Voltage Under Discharge Load < C/2
100%	> 52.5 VDC
95%	51.7 VDC
90%	51.65 VDC
75%	51.4 VDC
50%	51.0 VDC
20%	50.2 VDC
10%	49.5 VDC
0%	48.0 VDC



**CAUTION:** Before commissioning the system, the appropriate controller and inverter settings must be programmed per the manufacturer’s recommendations. Consult the manufacturer’s manuals and/or the Integration Guides listed on SimpliPhi’s [Product Documentation web page](#) (Schneider, Magnum, Outback, etc.). Failing to do so will damage the PHI batteries and will Void the Warranty. The following Charge Controller Integration tables are for general reference only.



**MISE EN GARDE:** Avant la mise en service du système, le contrôleur et l’onduleur doivent être programmés conformément aux recommandations du fabricant avec les réglages appropriés. Consultez les manuels du fabricant et/ou les Guides d’Intégration indiqués sur la page internet de la [Documentation Produit de SimpliPhi](#) (Schneider, Magnum, Outback, etc.). Ne pas respecter ces instructions endommagera les Batteries PHI Annulera la Garantie.

les tableaux d’Intégration du Contrôleur de Charge sont uniquement fournis à titre d’exemple.

## 6.0 – Troubleshooting

If your PHI Battery bank is reaching its Low Battery Cut Out voltage (LBCO), load disconnects or load shedding set points may need to be adjusted.

### The PHI batteries are reading extremely low or no voltage:

Programmed settings in the PHI Battery’s accompanying Balance of System equipment should prevent the PHI Battery’s internal BMS from reaching its low voltage setting. However, in the instance that the PHI Battery’s BMS has turned the PHI battery off, the battery will read low or no voltage, and the following steps should be taken to re-set the BMS:

1. Turn off each of the built-in breakers in all of the PHI Batteries in the battery bank\*.
2. Turn off the main DC disconnect located in the inverter’s power panel, between the battery bank and the inverter.
3. Turn off the main breaker at the top of the inverter’s AC distribution panel or sub-panel.
4. **Wait 5 minutes**, for the BMS in each battery to re-set itself.
5. Use a multi meter to take voltage measurements of each PHI battery in the battery bank, to make sure the voltage increased to the minimum voltage necessary for the inverter to turn on.

To measure a single battery’s voltage within a battery bank, only the battery being measured has its built-in breaker in the ON (I) position; all other batteries in the bank must have their built-in breakers OFF (O).

6. Turn on each of the built-in breakers in all of the PHI Batteries in the battery bank.
7. Turn on the main DC disconnect located in the inverter’s power panel.

8. Check that all parameters in the Balance of System equipment are programmed according to the relevant SimpliPhi Integration Guide. Failure to do so will damage the PHI batteries and Void the Warranty.
9. To charge the batteries quickly, SimpliPhi recommends using an AC power source to immediately charge the PHI battery bank via the inverter's charger. However, the PHI batteries will not incur any damage if they are charged using a connected solar PV array via the charge controller. The important aspect of this step is that the batteries re-charge as soon as the BMS has re-set.
10. Turn on the inverter's AC Input breaker and turn on the inverter.
11. The inverter should automatically self-initiate a battery charge. However, a Force Charge may need to be initiated in the inverter.

Not for reproduction

# Appendix A – PHI Battery Safety & Green Attributes, Certifications

This Appendix section covers the PHI Battery safety attributes and certifications, such as the lack of thermal runaway with fire propagation, off-gassing, UN DOT certification and UL compliance and certification. It also covers the PHI Battery's green attributes – from products to materials to disposal, as well as relevant environmental and ecological considerations.

## A.1 – Safety Attributes and Certifications

### A.1.1 – Intrinsically Safe Operation and Installation

The PHI Lithium Ferrous Phosphate (LFP) battery cell component is made with an intrinsically safe cathode material (iron phosphate). This creates a strong molecular bond, which withstands extreme conditions, prolongs cycle life, and maintains integrity with little or no maintenance over extended periods of time. There is virtually no danger of Thermal Runaway with fire propagation, as there may be with Lead Acid, NiCd, and Lithium Cobalt type batteries (NCA, NMC, LCO). No venting or cooling is required. No precautions or special structural considerations are necessary when installing PHI Batteries.

### A.1.2 – No Safety Hazards due to Off-Gassing, Exposure to Acids, Thermal Runaway

PHI Batteries do not vent dangerous gasses during normal operation, such as hydrogen and oxygen, because chemicals contained in Lithium Ferro Phosphate cells' electrolyte do not electrolyze to any appreciable extent within the PHI Battery's operating voltage range. In contrast, lead acid batteries which contain water and sulfuric acid experience significant electrolysis into H<sub>2</sub> and O<sub>2</sub> during normal operation. There are no dangers of exposure to sulfuric acid because PHI Batteries do not have caustic electrolytes. Thermal runaway with fire propagation is not an issue with PHI products due to the basic nature of Lithium Ferro Phosphate cell chemistry utilized in all our power storage products.

### A.1.3 – PHI Battery Control and Protective Circuitry

SimpliPhi Power Inc. utilizes balancing, voltage regulation, thermal and current controls, as well as other protective measures, in its PHI Battery Management System (BMS). This protective circuitry is embedded in the architecture of each PHI Battery.

### A.1.4 – UN DOT Certified Cells

The Lithium Ferrous Phosphate (LFP) cells are independently certified to withstand the UN DOT 38.3 testing guidelines with no special circuitry added. These tests include short circuit, over-voltage, overcharging, extreme temperature, high altitudes, shock and extreme vibration testing.

### A.1.5 – UL Compliance

The Lithium Ferrous Phosphate cells within the PHI Batteries fully comply with the safety testing parameters of UL 1642.

### A.1.6 – RoHS Compliant

SimpliPhi Power 3.8 Batteries are RoHS compliant. Any RoHS compliant component is tested for the presence of Lead (Pb), Cadmium (Cd), Mercury (Hg), Hexavalent chromium (Hex-Cr), Polybrominated biphenyls (PBB), and Polybrominated diphenyl ethers (PBDE). For Cadmium and Hexavalent chromium, there must be less than 0.01% of the substance by weight at raw homogeneous materials levels. For Lead, PBB, and PBDE, there must be no more than 0.1% of the material, when calculated by weight at raw homogeneous materials. Any RoHS compliant component must have 100 ppm or less of mercury and the mercury must not have been intentionally added to the component. In the EU, some military and medical equipment are exempt from RoHS compliance.

## A.2 – Green Attributes, Environmental & Ecological Considerations

### A.2.1 – Materials

The primary materials (lithium, iron, phosphate) that make up PHI Batteries are environmentally benign and pose very few polluting or environmentally degrading by-products in the harvesting and refinement processes. This is especially true when compared to those of lead acid, NMC, NCA, LCO, NiCad, and NiMH batteries.

### A.2.3 – Operation

There is no need for maintenance, such as adding water or chemicals, nor is there corrosion of terminals or containment facilities, or dispersion of fumes as with other battery types. Once installed, PHI Batteries are maintenance free as long as all the Installation Manual, Integration Guidelines and Warranty requirements are adhered to.

### A.2.4 – Life Cycles

PHI Batteries are designed for thousands of cycles while maintaining 80 percent or more of their initial capacity. To achieve this, it is critical to follow the operating conditions outlined in the Warranty.

### A.2.5 – Disposal

PHI products are non-hazardous, may be disposed of without damage to the ecosystem, and returned to the earth, while easily recombining with the elements without harmful by-products. The outer casing and brackets contain steel, aluminum, copper, cardboard, and recyclable plastic. Lithium Ferrous Phosphate (LFP) materials can also be recycled through established battery centers if desired.

### A.2.6 – Lithium Ferrous Phosphate Batteries and the Environment

As the use of this battery chemistry in larger batteries becomes more common, questions of sustainability and environmental impact inevitably arise. Of the lithium ferrous phosphate chemistries being considered for large format batteries, SimpliPhi Power believes that batteries based on our proprietary lithium ferrous phosphate chemistry and circuitry offer a clear advantage, not only over alternate Li-ion chemistries (lithium cobalt oxide), but all battery chemistries that are currently commercially available. This belief is based on the minimal environmental impact associated with the manufacturing of PHI Batteries, the extended cycle life and the significantly smaller end-of-life footprint that results from the use of PHI Batteries.

## A.3 – Summary

The Lithium Ferrous Phosphate (LFP) cells utilized throughout the entire PHI and LibertyPak product lines are classified as non-hazardous by OSHA and WHMIS. They are non-toxic, unlike NMC, NCA, LCO, NiMH, NiCad or Lead Acid types of batteries (including AGM). The PHI Batteries contain the least amount of toxic metals and are the most eco-friendly of all common battery types. Lithium easily combines into harmless compounds when disposed of. The PHI Batteries are the least polluting rechargeable batteries on the market today – no fumes, leaking, or gas discharge and no chemicals or acids to worry about. Designed and Manufactured in the USA Using Exclusive American Patented Technologies.



# Appendix B – PHI Battery Bank Sizing Guide

PHI 3.8 - M 51.2V <sub>nom</sub>	
Max Continuous Dis/charge Rate (ADC)	37.5
Max Continuous Dis/charge Rate (kW DC)	1.92

## 48V Sizing for Maximum Instantaneous Discharge (Load Rate)

Inverter Make / Model	Inverter Power Rating (kW AC)	Inverter Efficiency	Load Rate (kW DC)	PHI 3.8-M 51.2V <sub>nom</sub> Minimum Battery Quantity
Magnum MS 4448	4.4	94%	4.7	3
Magnum MS 4048	4	94%	4.3	3
OutBack Radian 8048A	8	93%	8.6	5
OutBack Radian 4048A	4	93%	4.3	3
OutBack SkyBox	5	97%	5.2	3
OutBack VFXR 3648A	3.6	93%	3.9	3
OutBack FXR 3048A	3	93%	3.2	2
OutBack GVFX 3648 (discontinued)	3.6	93%	3.9	3
OutBack GTFX 3048 (discontinued)	3	93%	3.2	2
Schneider XW Pro	6.8	93%	7.3	4
Schneider XW+ 6848	6.8	92.5%	7.4	4
Schneider XW+ 5548	5.5	93%	5.9	4
Schneider SW 4048	4	94%	4.3	3
Selectronic SP PRO SPMC 481-AU	5	96%	5.2	3
Selectronic SP PRO SPMC 482-AU	7.5	96%	7.8	5
Sol-Ark-8K	8	96.5%	8.3	5
Sol-Ark-12K	9	96%	9.3	5
Victron Quattro 48/3000/35	3	94%	3.2	2
Victron Quattro 48/5000/70	5	95%	5.3	3
Victron Quattro 48/10000/140	10	96%	10.4	6
Victron Quattro 48/15000/200 (230 VAC)	15	96%	15.6	9

# Sizing for Maximum Instantaneous Charge Rate

Assume charge controllers' current output is fully utilized.

		Minimum Battery Quantity
Charge Controller Make / Model	Max Output (ADC)	PHI 3.8 - 51.2V
Magnum PT-100	100	3
MidNite Solar Classic 150 - 48V system	86	3
MidNite Solar Classic 200 - 48V system	78	3
MidNite Solar Classic 250 - 48V system	55	2
MidNite Solar KID	30	1
MorningStar TriStar MPPT 600V	60	2
MorningStar TriStar TS-MPPT-60/60M	60	2
MorningStar TriStar TS-MPPT-45	45	2
MorningStar TriStar TS-MPPT-30	30	1
MorningStar TriStar ProStar PS-MPPT-25/25M	25	1
MorningStar TriStar ProStar PS-MPPT-40/40M	40	2
OutBack FM 100	100	3
Schneider MPPT 60 150	60	2
Schneider MPPT 80 600	80	3
Sol-Ark-12K (includes dual MPPTs)	185	5
Victron SmartSolar MPPT 250/60	60	2
Victron SmartSolar MPPT 250/70	70	2
Victron SmartSolar MPPT 250/85	85	3
Victron SmartSolar MPPT 250/100	100	3

# Appendix C – PHI Approved External Chargers

This Appendix section covers the PHI Battery's approved external / plug-in chargers.

Typically, ancillary charging of SimpliPhi's batteries **is not required**, and charging using any of the charge controllers and/or inverter/chargers listed in the "Integration Guides" section of the SimpliPhi web site's [Product Documentation](#) page is acceptable. However, ancillary charging may be necessary in the following situations:

1. No charge controller or inverter/charger is available
2. Increasing the battery's State of Charge (SoC) after an extended storage period and prior to installation
3. For recharge purposes when the battery's voltage is below the minimum required voltage for charge controller and/or inverter/charger equipment to turn on

## C.1 – Recommended 48V Charger

The 54.6V 4A 13 Series 48V LiFePO4 Smart Charger from WAOUKS is recommended and available online for purchase [at this link](#).

The 58.4V 5A 16 Series 48V LiFePO4 Smart Charger from WAOUKS is recommended and available online for purchase [at this link](#).

The 48V/30A for LiFePO4 / LiFeYPO4 (58.8V) + GMS charger from GWL/Power is recommended and available for online purchase [at this link](#).

The Smart Charger (15A) for 51.2V (16 cells) LiFePO4 Battery Pack – CH-PFC51215A charger from AA Portable Power Corp is available online for purchase [at this link](#).

## C.4 – Alternative Chargers

If the above listed chargers are unavailable or undeliverable to your specific location, SimpliPhi also approves of Iota Engineering's battery chargers ([link here](#)) to increase the PHI battery's voltage. These chargers should only be used in order to increase battery voltage enough to regain system operability; these chargers should not be used to regularly and fully charge the PHI battery.